

ASSEMBLY AND INSTALLATION INSTRUCTIONS

FOR YOUR SAFETY WARNING: BE SURE THE ELECTRICITY TO THE WIRES YOU ARE WORKING ON IS SHUT OFF; EITHER THE FUSE IS REMOVED OR THE CIRCUIT BREAKER IS SHUT OFF. GENERAL You don't need special tools to install this fixture. Be sure to follow the steps in the order given. Under no circumstances should a fixture be hung on house electrical wires, nor should a swag type fixture be installed on a ceiling which contains a radiant type heating system. Read instructions carefully. If you are unclear as to how to proceed, consult a qualified electrician. NOTE: Proper wiring is essential for the safe operation of this fixture.

Carefully remove the fixture from the carton, and check that all parts are included, as shown in figure. Be careful not to misplace any of the screws or parts which are needed for installing the fixture.

Assembly and Installation Step:

1. Make wire connections with wire nuts:
 - a. The black wire from fixture to the black wire from power source.
 - b. The white wire from fixture to the white wire from power source.
 - c. Attach the ground wire from the fixture to the outlet box ground screw or to the green screw located on the crossbar.
2. Place the Fixture to the Post, and then secure with the 3 Mounting Screws.
3. Install lamp.
4. Attach the Cover onto the Fixture, and then secure with the 2 Set Screws.
5. Turn on the power at fuse or circuit box.

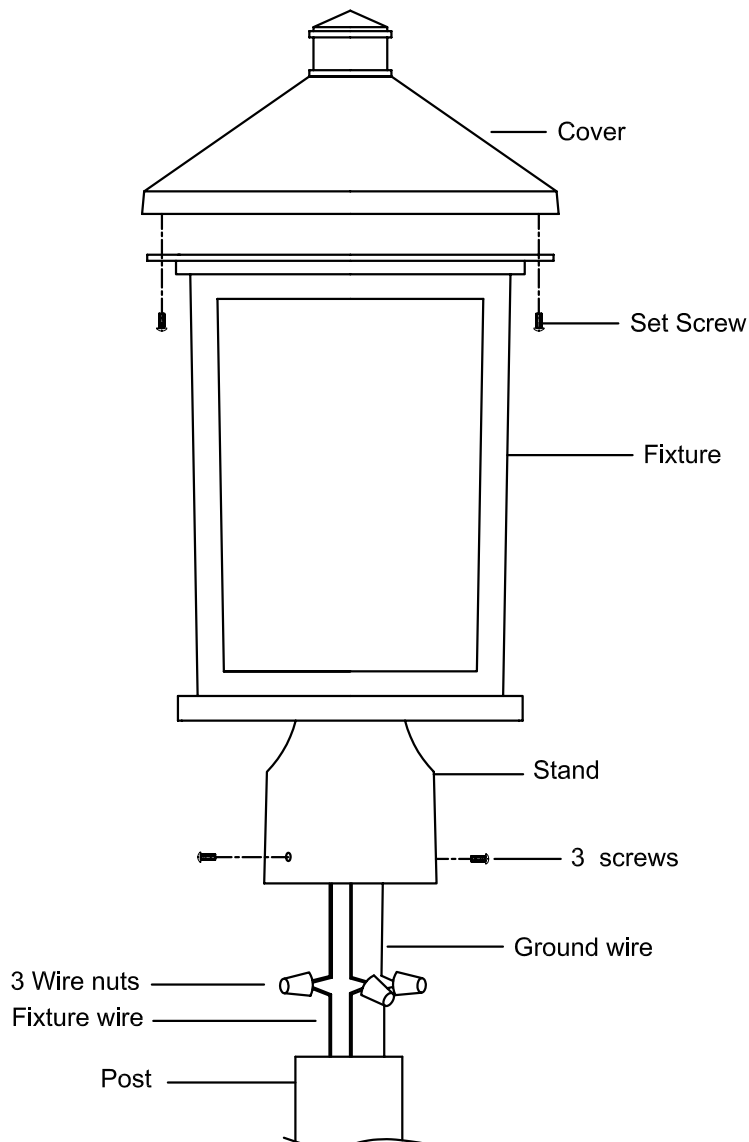

Please observe local building/electrical codes regarding the installation of your post fixture. Please keep in mind your geographic location and the depth that the ground freezes to, when deciding the depth of your installation.

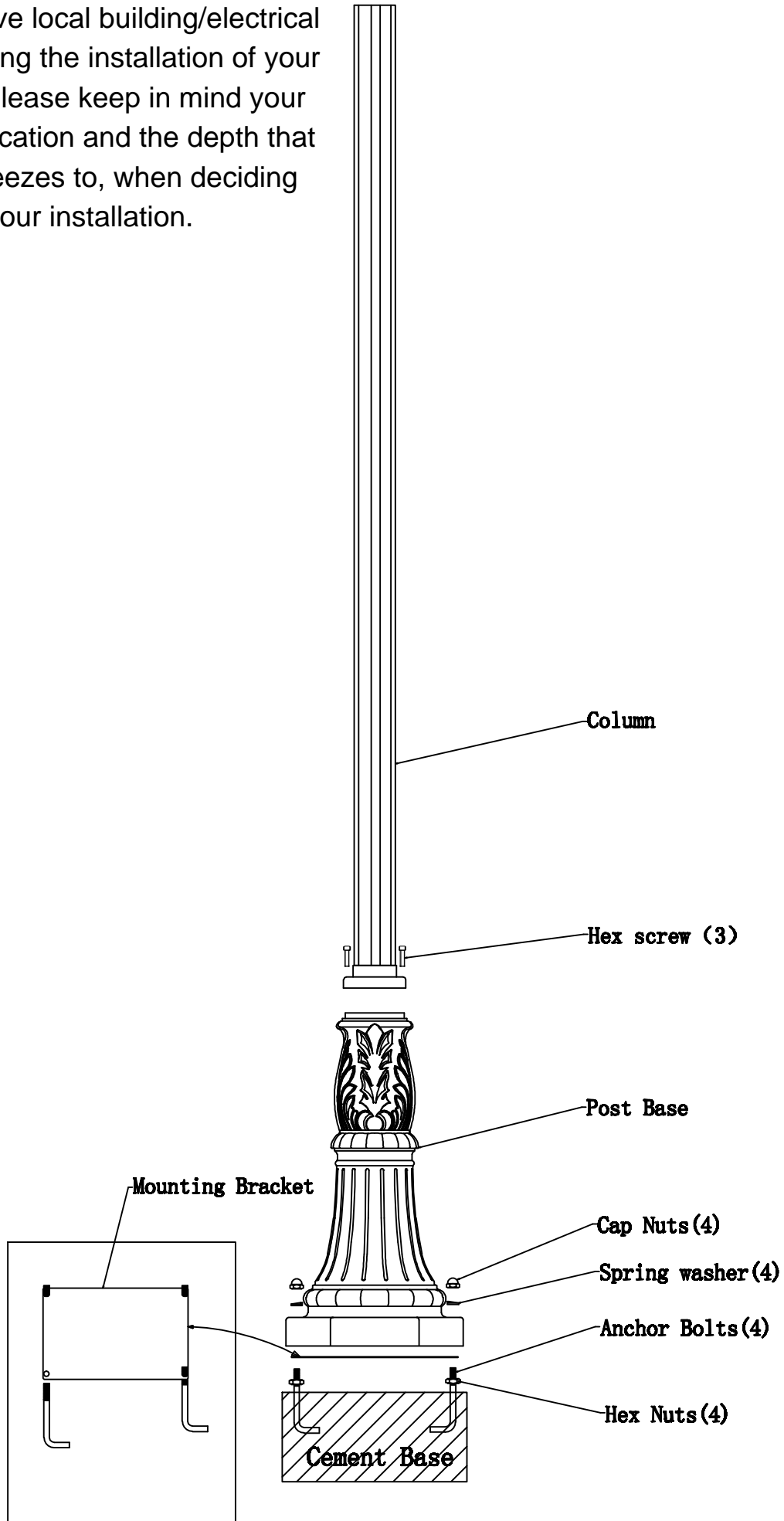

518P-BK